

FRK4

4" NON-IC, Architectural LED Retrofit Downlight







14W & 22W LED, 120V ~ 277V Input



Catalog #		Type
Project		Date
Prepared by		

4" Architectural LED



 TML-149R Open Reflector	 TML-140B Baffle w/ Reflector	 TML-146B Baffle w/ Regressed Lens
 TML-146R Reflector w/ Regressed Lens	 TML-141 Wall Wash w/ Kick-off Plate	 TML-148 Reflector w/ Frosted Floating Lens

* All trims are rated for damp location, and regressed lens trims are for wet location listed.
* Wide beam reflector is standard. Also available in other beam in reflector.(consult with factory)

LINE DRAWING

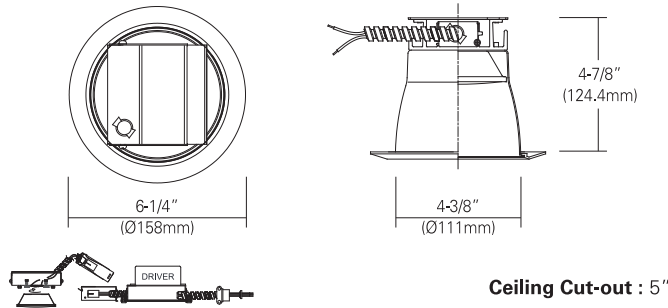

SPECIFICATION

LED Quantity	1EA (COB)	
Input Voltage	120V ~ 277V AC	
Wattage (Typ)	14 W	22 W
Lumen (Typ)	1,400	1,980
Efficacy (LPW)	100 lm/W	90 lm/W
Beam Angle	67.7°	69.3°
CRI (Typical)	80, 90	
Color (+/-5%)	2700K, 3000K, 3500K, 4000K, 5000K	
Dimming	Triac & 0-10V the both(Consult with factory for approved dimmers)	

DESCRIPTION

The 4" Architectural grade LED Recessed Downlight Retrofit Trim Module with Clear Cone reflector. Designed for use with existing ISLT 4" Architectural Incandescent, Fluorescent and Metal Halide Housing. Also, compatible with most 4" architectural housings measuring aperture between 4-1/2" ~ 5" (See Housing Compatibility section).

FEATURES and FUNCTIONS

- Heavy gauge aluminum reflector anodized in clear, haze, gold, champagne and pewter color finish.
- Aluminum extruded Heat sink designed to facilitate heat dissipation.
- Designed for use with most existing 4-1/2" ~ 5" aperture architectural incandescent, fluorescent and metal halide housings.
- Beam optic changeable with easy twist-on lock.
- Easy-quick metal connector case supplied allowing easy and sturdier wire connector. (USA patented)
- 120V~277V 60Hz Triac and 0-10V dimmable driver for most dimmers in the market.

Provided : Easy-quick connector case

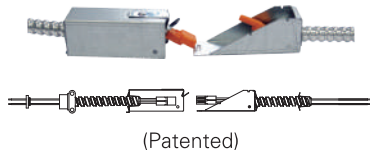

Listing

- CSA-us & cETL
- Energy star Approved & Listed
- State of california Title 24
- Wet location

Warranty

- 5years of lamp life.

ORDERING INFORMATION

Housing	Watts	CRI	CCT	Driver	Trim	Reflector Finish	Baffle Finish	Optional Metal Trim Ring Finish
FRK4 4" Non-IC, Architectural LED Retrofit downlight	14 14W	8 80	27 2700K	UTD 120V, Triac Dimming (Standard) UZTD 120~277V, 0~10V Dimming	TML-149R	HC Haze Clear	WH White	WH White
	22 22W	9 90	30 3000K 35 3500K 40 4000K 50 5000K		TML-140B TML-146B TML-146R TML-141 TML-148	WH White	BK Black	BK Black
*Option - EM=Emergency battery backup					*Consult with factory for custom finishes			

Example : FRK4-22-830-UTD

- - -

Example : TML-149R-HC-WH

- -

FRK and SFK 4, 6, 8, 9

120V&277V AC, Non-IC LED Retrofit-Kit

Architectural LED

APPROVED DIMMER

Triac Approved Dimmers

- **Lutron** : Skylark - SLV Series, SCL Series, Contour Series, Homeworks - RPM-4U*, QS HQRD-6ND Series, QS HQRD-10ND Series, Diva - DVCL Series, DVLV Series*, Nova T NT Series, Glyder GLV Series, Ariadni AYCL Series, RadioRA 2 10ND Series, Maestro Wireless MRF 2-6ND Series
- **Lutron** : Skylark SELV Series*, Homeworks QS HQRD-6NA*, Maestro - MAELV Series*, MRF 2-6ELV Series*, Diva DVELV Series*, Nova T☆ NTELV Series*, RadioRA RRD-6NA Series*
- **Leviton** : SureSlide 6633*

0-10V Approved Dimmers

- **Lutron** : Nova® 0-10V : NTFTV, Diva® 0-10V : DVTV
- **Leviton** : Decora 0-10V : IP710DL

*Consult tech. service or factory for additional dimmers.

HOUSING COMPATIBILITY

FRK and SFK Series ETL Listed for installation in the following Ilung standard architectural housings

4"	DLF-466, DLF-146(R), DLF-416(R), DLF-426, DL-4200A, DL-1420(R)A, DL-4200H, DL-1420(R)H
6"	DLF-666, DLF-166(R), DLF-616(R), DLF-626, DL-6200A, DL-1620(R)A, DL-6235A, DL-1635(R)A, DL-6200H, DL-1620(R)H, DL-6235H, DL-1635(R)H
8"	DLF-866, DLF-186(R), DLF-816(R), DLF-826, DL-8200A, DL-1820(R)A, DL-8235A, DL-1835(R)A, DL-8200H, DL-1820(R)H, DL-8235H, DL-1835(R)H
9"	DLF-966, DLF-196(R), DLF-916(R), DLF-926, DL-9200A, DL-1920(R)A, DL-9235A, DL-1935(R)A, DL-9200H, DL-1920(R)H, DL-9235H, DL-1935(R)H

FRK and SFK Series ETL Classified for retrofit in the following 6", 8" architectural housings

6"	<ul style="list-style-type: none">• Halo : PD6V142E, PD6V120, PD6V501E, PD6V701E, PD6V1001E• Juno : CV6-118T, CV6-126Q, CV6-126/32T, TC906, MX6-(50,70,100), M6-(70,100)• Lithonia : LP6F, CCR62, LP6H, LP6, LV
8"	<ul style="list-style-type: none">• Halo : PD7V142E, PD7V120, PD7V501E, PD7V701E, PD7V1001E, PD7V70X1E, PD7V10X1E• Juno : CV8-126 / 32 / 42T, TC908, MX8-(70,100), M8-(70,100)• Lithonia : LP8F, CCR82, LP8H, LP8