

STL-830

120V, 220V-230V and 277V

LED Mini Step Light

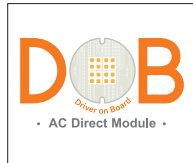

Catalog #		Type
Project		Date
Prepared by		

Step LED

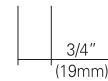
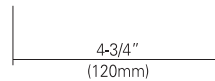
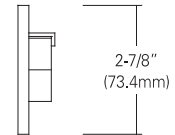
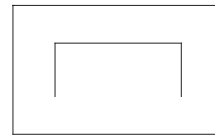
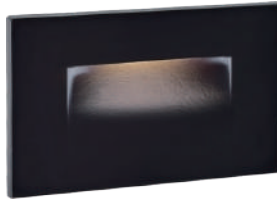

WHITE

BLACK

DESCRIPTION

The STL-830 LED Mini Step Light is a easy-to-install low profile fixture that produces an attractive glow. Ideal for lighting low light areas such as corridors or pathways, and can be mounted vertically or horizontally. Available in Outdoor and indoor as well.

SPECIFICATION

HOUSING	STL-830
Wattage (Typ)	5W
Lumen (Typ)	215
Efficacy (LPW)	43 lm/W
C R I (Typical)	80, 90
Color (+/-5%)	2700K, 3000K, 4000K, 5000K
Dimming	Triac or 0-10V(Consult with factory for approved dimmers)

FEATURES and FUNCTIONS

- Cast aluminum face plate.
- Wet location listed to IP65 for indoor and outdoor installation.
- Diffused lens delivers perfect light distribution.
- 120V AC LED module with integrated IC chip imbed on board and 10-100% Triac dimming with most of leading and trailing edge dimmer switches in the market. Also available with 220V-230V AC module.
- 120V or 277V direct wiring , no drive needed.

Listing

- CSA-us Certified
- Wet location
- State of california Title 24

Warranty

- 5years of lamp life.

Installation

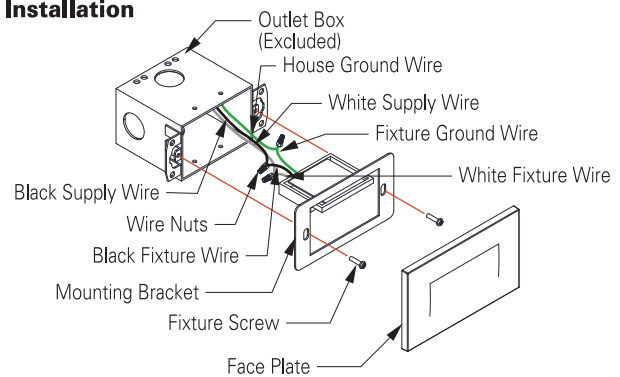

ORDERING INFORMATION

Housing	CRI	CCT	Finish
STL-830 5W	8 80	27 2700K	WH White
	9 90	30 3000K	BK Black
		40 4000K	BZ Bronze
		50 5000K	

*Consult with factory for custom finishes

Example : STL-830-927-BK

- -